

HOBIE T1

Eclaté des pièces détachées / Illustrated Part Guide / Explosionszeichnung

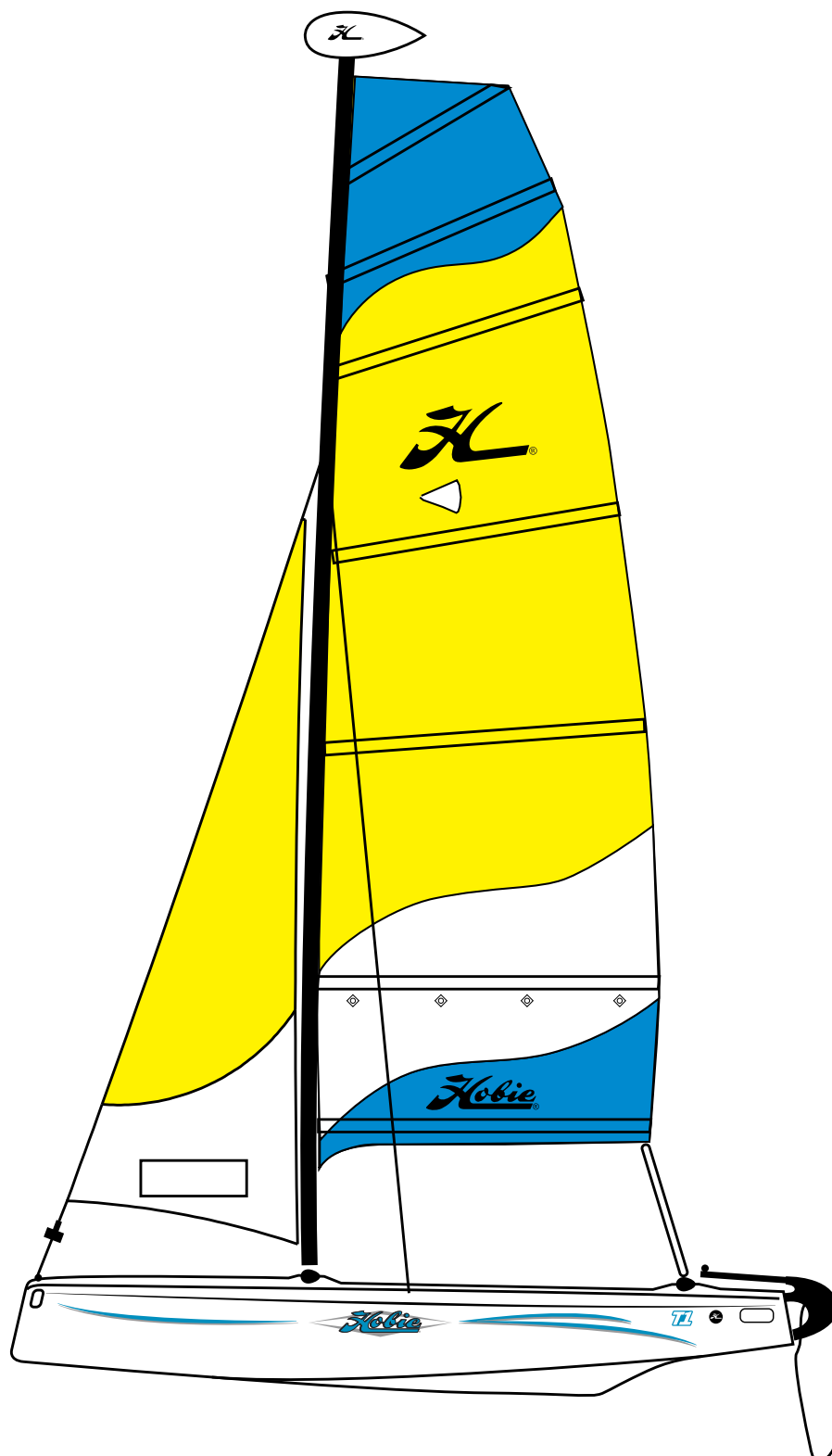

Ref : ECL_t1	Issued by : MB	Date : 12/2015	Update : 1	Page : 2/23
--------------	----------------	----------------	------------	-------------

HOBIE T1

Eclaté des pièces détachées / Illustrated Part Guide / Explosionszeichnung

Sommaire / Table of content / Inhalt

Page / Seiten	Intitulé / Description / Inhalt
2	Sommaire
3	Coques / Hulls / Rümpfe
4	Traverse avant / Front crossbar / Vorderholm
5	Traverse arrière / Rear crossbar / Achterholm
6	Trampoline mesh / Mesh trampoline / Netztrampoline
7	Mât / Mast
8	Jeu de câbles ss enrouleur / Wire set w/o furler / Käbelsatz o. Roller
9	Jeu de câbles avec enrouleur / Wire set with furler / Käbelsatz m. Roller
10	Haubans / Shrouds / Wanten
11	Trapèze / Trapeze / Trapez
12	Gouvernail / Rudder assembly / Ruderanlage
13	Barre d'accouplement & stick / Tiller crossbar & extension / Anlenkstange & Pinne
14	Grand-voile / Main sail / Großsegel
15	Palan de grand-voile / Mainsheet system / Großschot-System
16	Foc / Jib / Fock
17	Tangon / Spi boom / Spibaum (Option)
18-19	Kit Spinnaker (Option)
20	Contact

HOBIE T1

Eclaté des pièces détachées / Illustrated Part Guide / Explosionszeichnung

Coques / Hulls / Rümpfe

N°	Ref	Designation/Description/Beschreibung
	56020000	Coque droite / Right Hull / Rumpf rechts 2014
	56010000	Coque gauche / Left hull / Rumpf links 2014
1	99061400	Cadène de hauban / Shroud anchor plate
2	56341000	Rail de trampolin / Tramp track
	8031130	Vis / Screw / Schraube 10X3/4"
3	99061705	Fémelot EZ Loc 2 trous / Pintle 2 screws / Ruderbeschlag 2 Schraube (x2)
4	99061710	Fémelot EZ Loc 4 trous / Pintle 4 screws / Ruderbeschlag 4 Schraube (x2)
5-6	16262120	Goupille + cable + vis 6x50 Retaining clip + cable + screw 6x50 Sicherungsclip + Kabel + Schraube 6x50
5	16552190	Goupille / Retaining clip / Sicherungsclip
6	99220338	Vis / Screw / Schraube 6x50
	99220032	Rondelles / Washer / Unterlegscheibe D6 (x10)
	99220019	Ecrou indessérable / Nylstop nut / Selbstsichernde Mutter D6 (x10)

N°	Ref	Designation/Description/Beschreibung
7	99220041	Joint de vidange / Drain gasket / Dichtung Ablassschraube (x10)
8	99220040	Bouchon de vidange+ joint / Drain Plug + gasket / Ablassschraube + Dichtung (x10)
Autocollants / Decals		
9	79545	Dome Hobie Gold
10	12451061	Hobie Diamond (IML)
11	12450015	Vague / Wave
12		Hobie T1 (IML)

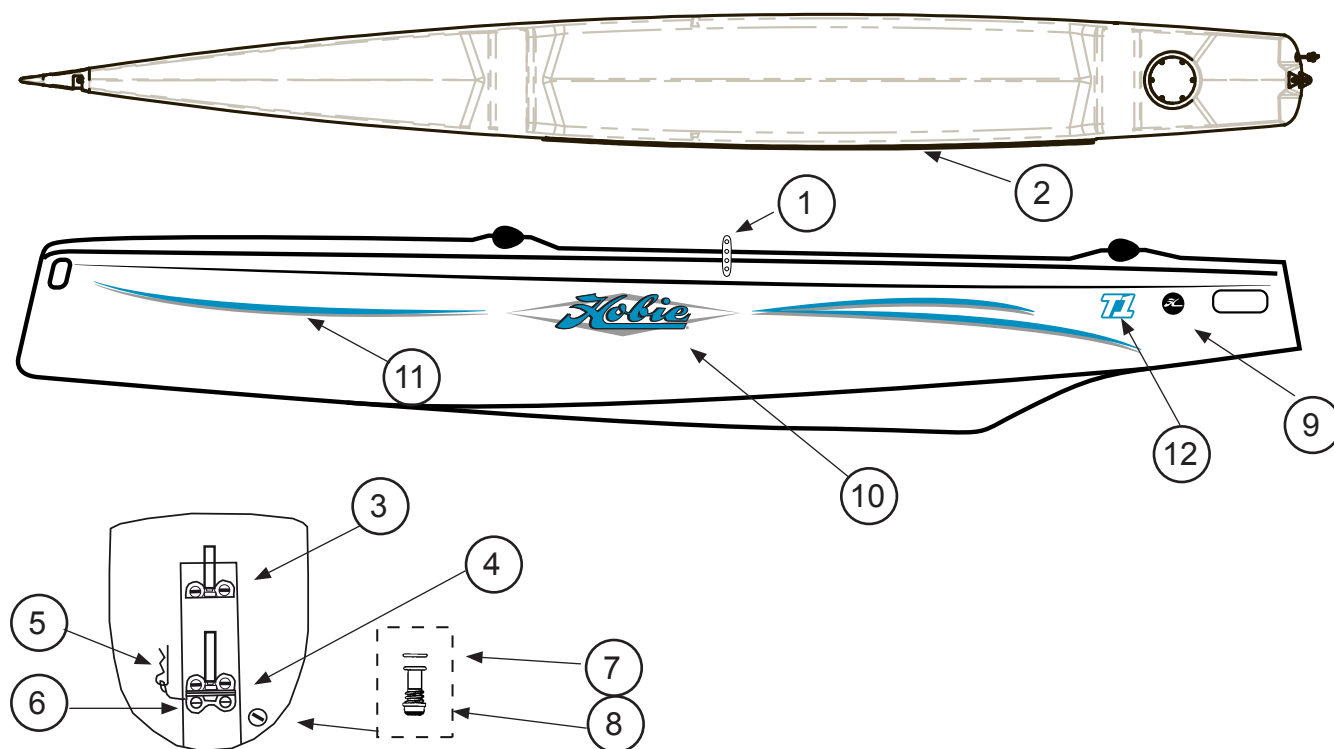

HOBIE T1

Eclaté des pièces détachées / Illustrated Part Guide / Explosionszeichnung

Traverse avant / Front crossbar / Vorderholm (Vue avant / Front view)

N°	Ref	Designation/Description/Beschreibung
	56100001	EXT TRAVERSE AVANT / FRONT CROSSBAR EXT /VORDERHOLM EXT T1
1	56100008	Vis / Screw / Schraube M12 x 82.5 mm
2	56100007	Entretoise / Bolt cap /
3	39130020	Bouchon AV noir / Endcap front black
4	38171000	Casting pied de mât / Casting mast base Wave/T1
5	38170000	Tige filetée HW T1 / Stud HW T1 mast step
6	50212300	boule de mât / Mast ball
7	11900010	Support tourelle
8	56100011	Tourelle / Swivel Cam cleat
9	11470010	Pontet / Padeye

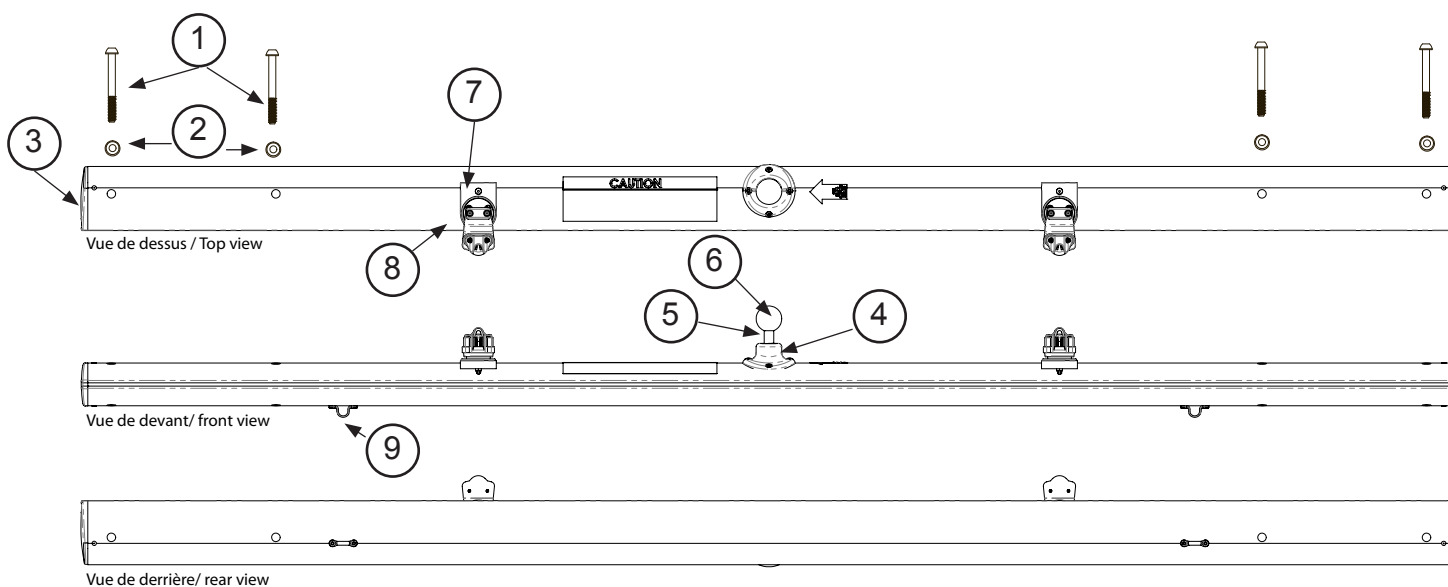

HOBIE T1

Eclaté des pièces détachées / Illustrated Part Guide / Explosionszeichnung

Traverse arrière / Rear crossbar / Achterholm

N°	Ref	Designation/Description/Beschreibung
	56100002	Ext. Traverse AR T1 / Rear crossbar ext. T1 / Achterholm Ext. T1
1	56100008	Vis / Screw / Schraube M12 x 82.5 mm
2	56100007	Entretoise / Bolt cap /
3	39190020	Bouchon AR noir / Endcap aft black
4	38760040	Support tourelle / Cam Cleat plate
5	56100011	Tourelle Cam Cleat / Swivel Cam Cleat
6	11800001	Chariot de GV / Main traveler car assembly
7	41220000	Bouton de laçage / Eyelet post

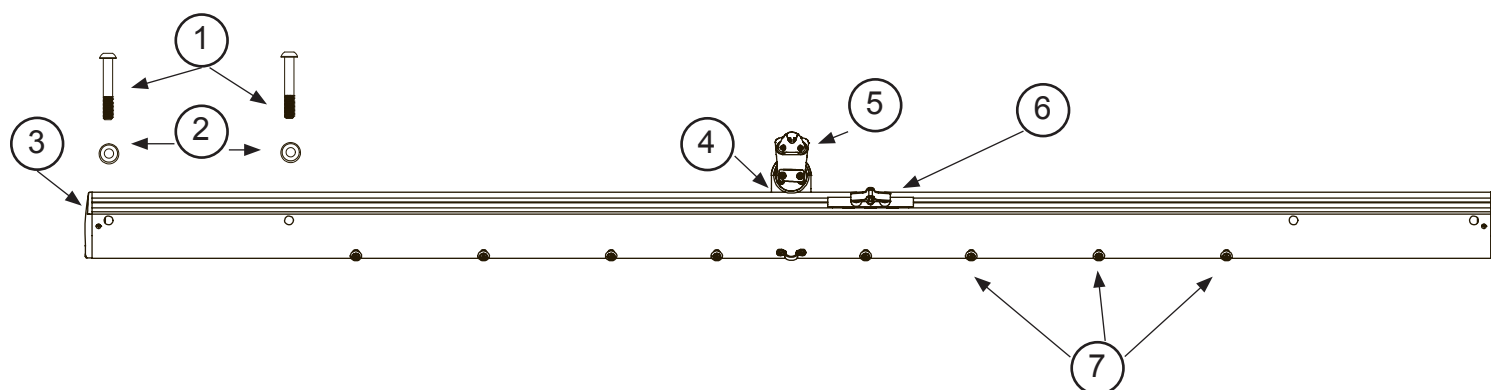

HOBIE T1

Eclaté des pièces détachées / Illustrated Part Guide / Explosionszeichnung

Trampoline mesh / Mesh trampoline / Netztrampoline

N°	Ref	Designation/Description/Beschreibung
	569700581	Trampoline mesh Mesh Trampoline Netztrampoline
	56100006	Jonc trampoline Fibreglas lacing rod Trampolinestange

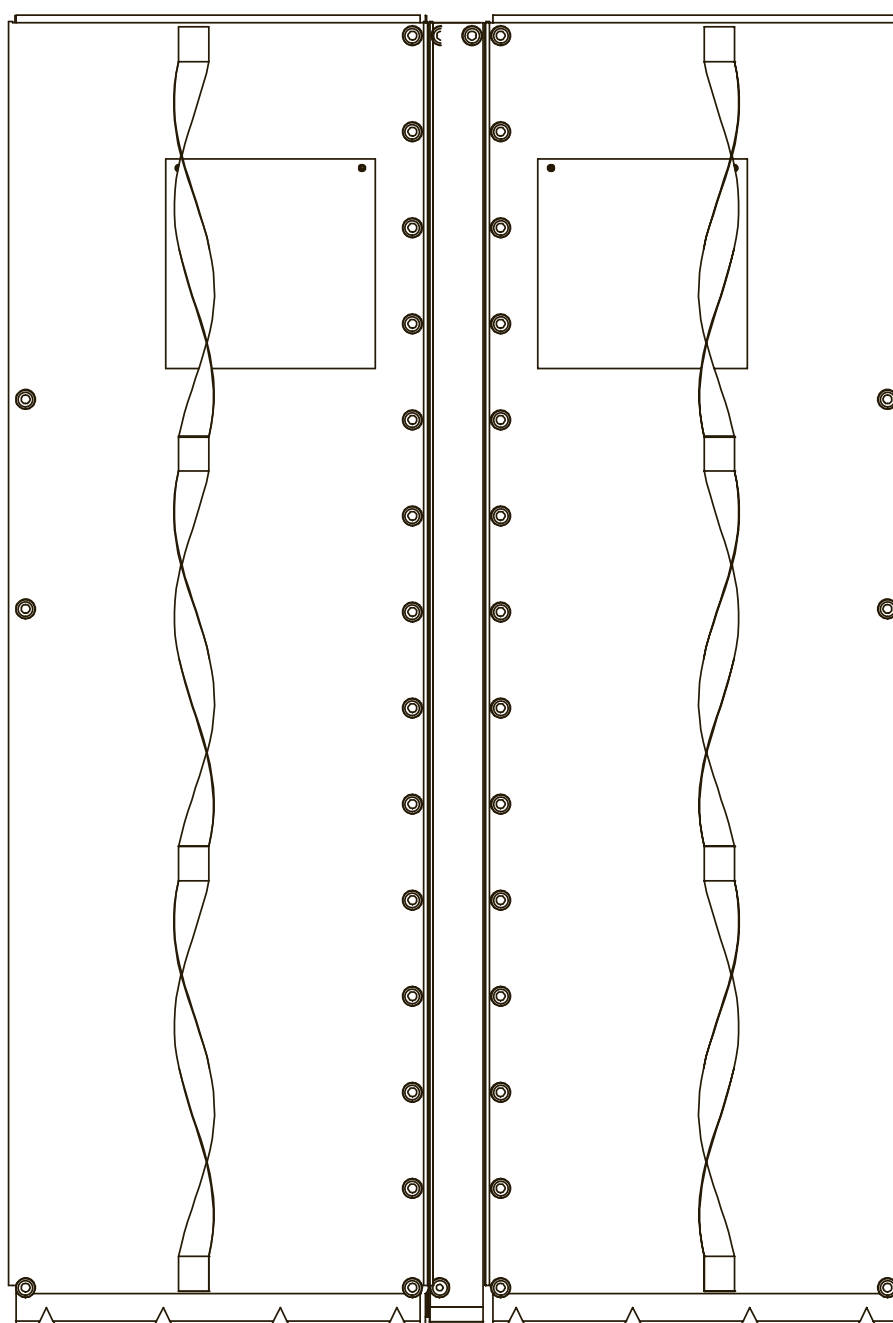

HOBIE T1

Eclaté des pièces détachées / Illustrated Part Guide / Explosionszeichnung

Mât / Mast

N°	Ref	Designation/Description/Beschreibung
	14642700	Mât 1 p / 1-piece Mast / 1-teiliger Mast
		Mât 2 p / 2-piece Mast / 2-teiliger Mast
1	14000005	Tête de mât / Mast head / Mastkopf
2	14041712	Réa Nylon /Nylon sheave / Rolle D 130
3	14041713	Axe tête de mât (x5) Mast head sheave pin (x5) Bolzen Mastkopf (x5)
4	14641750	Drisse cable grand voile Main halyard wire Grossfall Kabel
5	99500210	Crochet GV/Cuni 4 mm (x2)
6	14041721	Hook de drisse / Halyard hook / Fallhaken
7	14041722	Ferrure de capelage Mast tang Mastbeschlag
8	14041723	Autocollant de sécurité Mast caution label Sicherheitsaufkleber
9	99220050	Taquet de drisse (x10) Halyard Cleat (x10) Niederholer Mastklemme (x10)
	99210050	Rivets Bouchons étanches / waterproof rivets / Wasserdicht Dichtungen (x10)
10	14041715	Taquet étarq amure / Downhall cleat / Klampe (x10)
	99220051	Vis / Screw / Schraube TFBF 4 x 30 mm
	99220052	Ecrou carré / Square nut M4
11	13600010	Base de mât / Mast base / Mastfuss
	99220116	Vis/Bolt/Schraube TFF 6x55
	99220019	Ecrou/nut/Mutter D6 (x10)
12	14042720	Sceau de mât PVC Mast plug Mast Abdichtung
13	99220238	Ferrure fixation mât / mast fixation
14	KFPM	Kit flotteur de mât complet Mast float kit complete Torpedo komplett

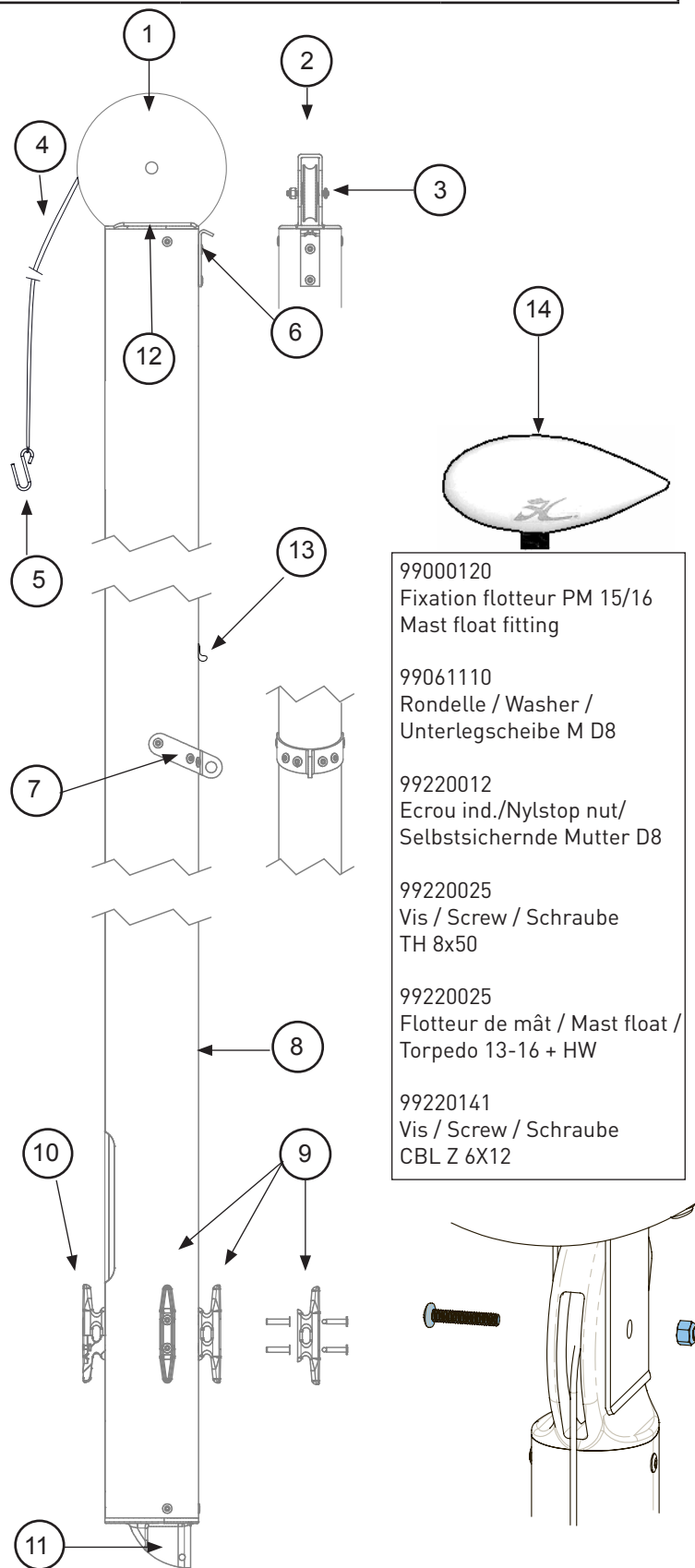

HOBIE T1

Eclaté des pièces détachées / Illustrated Part Guide / Explosionszeichnung

Jeu de câbles ss enrouleur / Wire set w/o furler / Kábelsatz o. Rollertrommel

N°	Ref	Designation/Description/Beschreibung
	14680500	Jeu de câbles / Wire set / Kábelsatz
		Sac accastillage / Rig bag / Takelagebeutel
		Sac de cordages / line bag / Leinesack
1	14680570	Bride / Bridle / Hahnepot
2	14660525	Etai cable + estrope Forestay + pigtail Vorstag Kabel + Pigtail
3	99220036	Manille lyre / Shackle / Shäkel 4mm (x10)
4	16080515	Poulie drisse foc (grande) Jib Halyard block (large) Fockfallumlenkblock gross
5	16080516	Poulie drisse foc (petite) Jib halyard block (small) Fockfallumlenkblock klein
6		Cordage drisse de foc Jib halyard rope Fockfall-Leine
7	99220031	Anneau brisé / Split ring / Ringsplint (x10)
8	99220034	Axe percé / Clevis pin / Bolzen für Locheisen (x10)
9	99220033	Latte ridoir universelle (x5) Stay adjuster (x5) Locheisen (x5)
10	99220035	Manille lyre / Shackle / Schäkel 6mm (x10)
11	18060007	Manille large / Large Shackle / Schäkel breit
12	14662300	Barre de maintien parallèle Spreader bar 20124 Parallelholm 2014
13	99220121	Embout percé barre accouplement drilled end cap for tiller crossbar Endstück gebohrt f. Anlenkstange
14	16663032	Vis à oeil / Eye-screw /

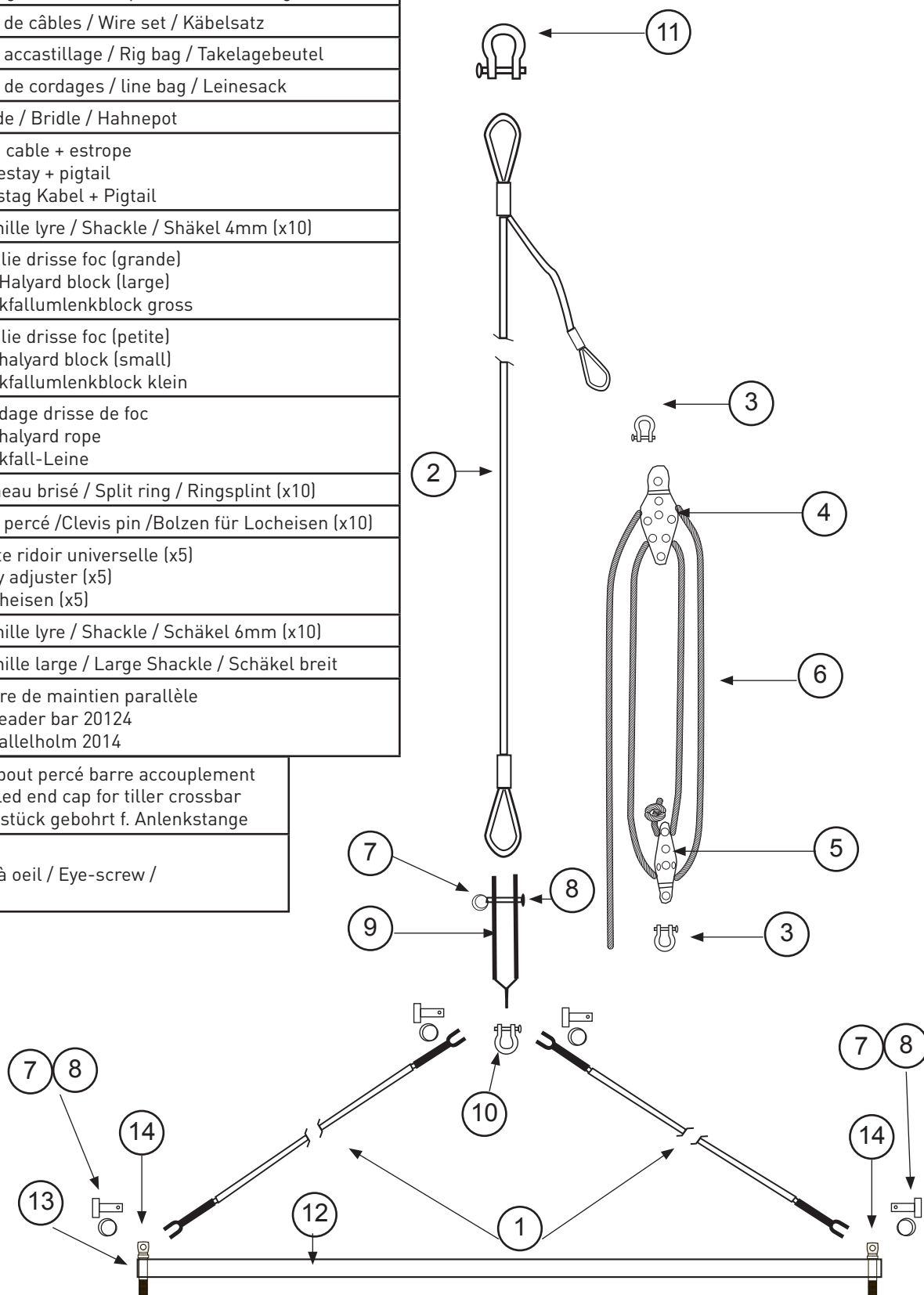

HOBIE T1

Eclaté des pièces détachées / Illustrated Part Guide / Explosionszeichnung

Jeu de câbles avec enrouleur / Wire set with furler / Kâbelsatz m. Rollertrommel (OPTION)

N°	Ref	Designation/Description/Beschreibung
	14670350	Accastillage Foc enrouleur T1 / Furler jib rig / Rollerfock Rig
1	18060007	Manille large / Large shackle
2-3	18560535	Estrope + émerillon / Pigtail + Swivel
3	18060590	Émerillon / Forestay swivel / Fockvorstagwirbel
4	99220034	Axe percé / Clevis pin / Bolzen für Locheisen (x10)
5	99220031	Anneau brisé / Split ring / Ringsplint (x10)
6	99500474	Poulie simple ringot / Single block / Block einzig
7	99500478	Poulie simple micro / Single block micro / Block einzig micro
8	14660530	Étai câble pour enrouleur / Forestay wire for jib furler / Vorstagkabel für Rollertrommel
9	99220350	Latte ridoir / Stay adjuster / Locheisen
10	99220036	Manille lyre / Shackle / Shäkel 4mm (x10)
11	21060150	Enrouleur / Jib furler / Focktrommel
12	14680590	Bride / Bridle / Hahnepot
13	14662300	Barre de maintien parallèle / Spreader bar / Parallelholm
14	99220121	Embout percé barre accouplement / drilled end cap for tiller crossbar / Endstück gebohrt f. Anlenkstange
15	99300590	Bout enrouleur / Jib furler line / Rollertrommel Leine
16	99300610	Cordage D4 noir Regatta / Black Line D4 Regatta / Leine D4 Regatta schwarz
17	16680540	Drisse gréage / Mounting halyard /
18	18670444	Bout étarquage foc / Jib tensioning line
	99500416	Taquet enrouleur (traverse avant) / Furler cleat (front crossbar) / Rollerfock klemme (vorderholm)

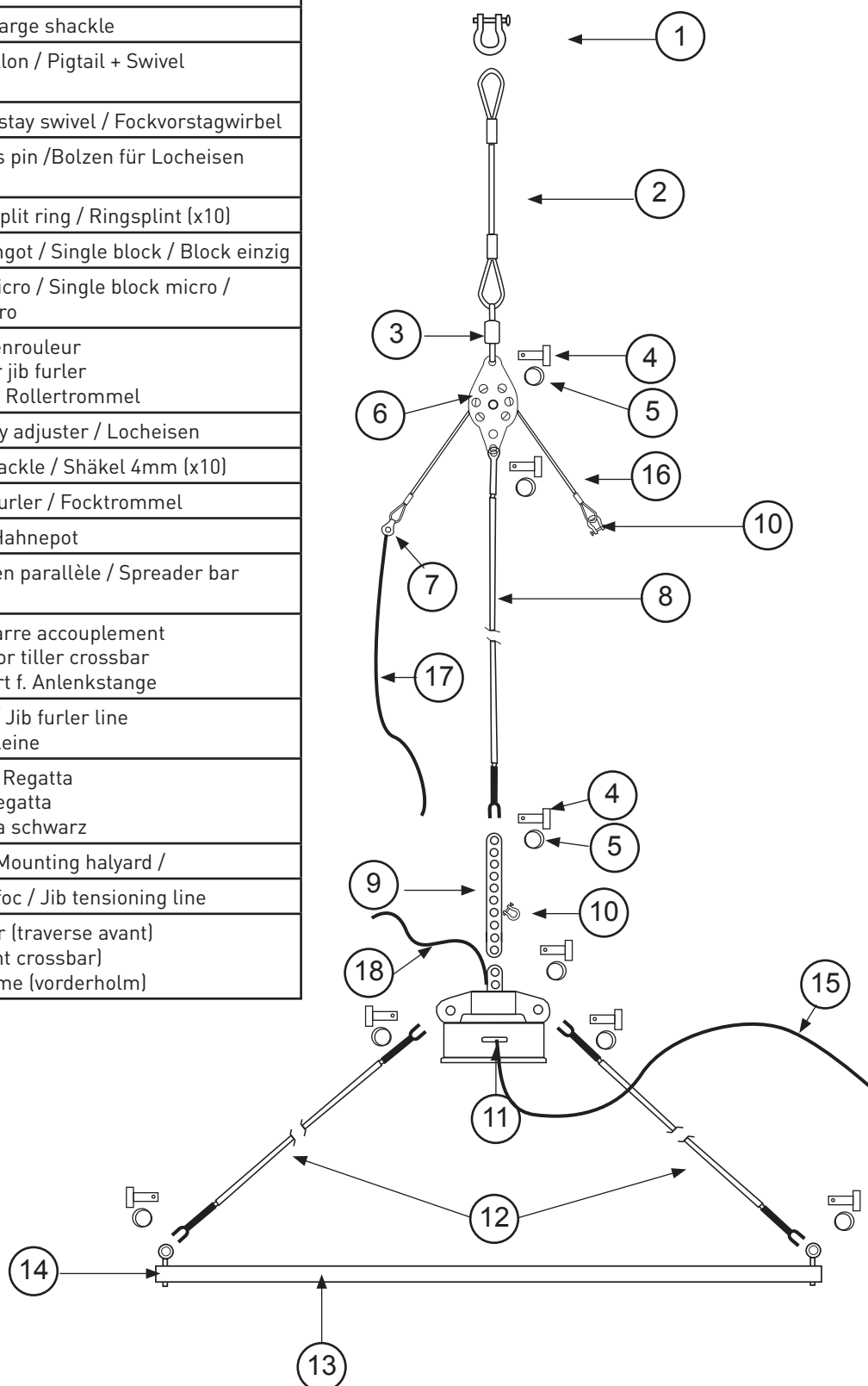

HOBIE T1

Eclaté des pièces détachées / Illustrated Part Guide / Explosionszeichnung

Haubans / Shrouds / Wanten

N°	Ref	Designation/Description/Beschreibung
	14680500	Jeu de câbles T1 Wire set T1 Käbelsatz T1
1	18060007	Manille large / Large shackle
2	14680560	Hauban Shroud Wanten
3	99500360	Gaine latte ridoire (x10) Shroud adjuster cover (x10) Wantenschutz (x10)
4	99220034	Axe percé latte ridoir (x10) Clevis pin (x10) Bolzen für Wanteisen (x10)
5	99220031	Anneau brisé (x10) Split ring (x10) Ringsplint (x10)
6	99220033	Latte ridoir universelle (x5) Stay adjuster (x5) Wantenspanner (x5)

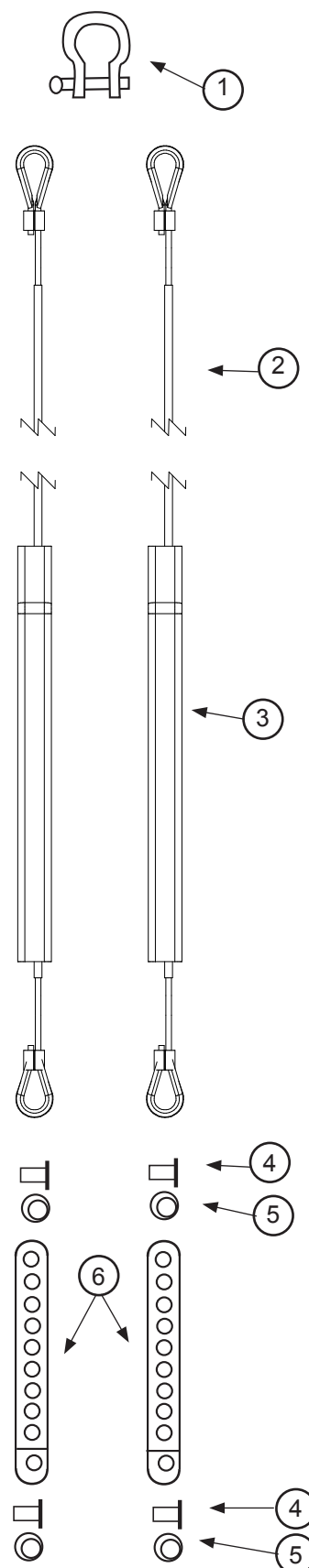

HOBIE T1

Eclaté des pièces détachées / Illustrated Part Guide / Explosionszeichnung

Trapèze / Trapeze / Trapez

N°	Ref	Designation/Description/Beschreibung
	14680540	Kit trapèze 2 câbles / Trapeze Kit 2 wires Kit Trapez 2 Kâbel
1-2	14680515	Cable trapèze gainé Coated trapeze wire Trapezkabel überzogen
2	16080552	Poignée de trapèze Trapeze handle Trapezgriff
3	99500020	Poignée J&H (x10) J&H handle (x10) J&H Trapezgriff (x10)
4	18060301	Double anneau (x10) Rope lock (x10) Trapezstopper (x10)
5	16080554	Cordage D6 bleu Trapeze line D6 blue Trapezleine D6 blau
6	99300414	Sandow trapèze noir / Trapeze shock cord black / Gummistropschwarz - D6

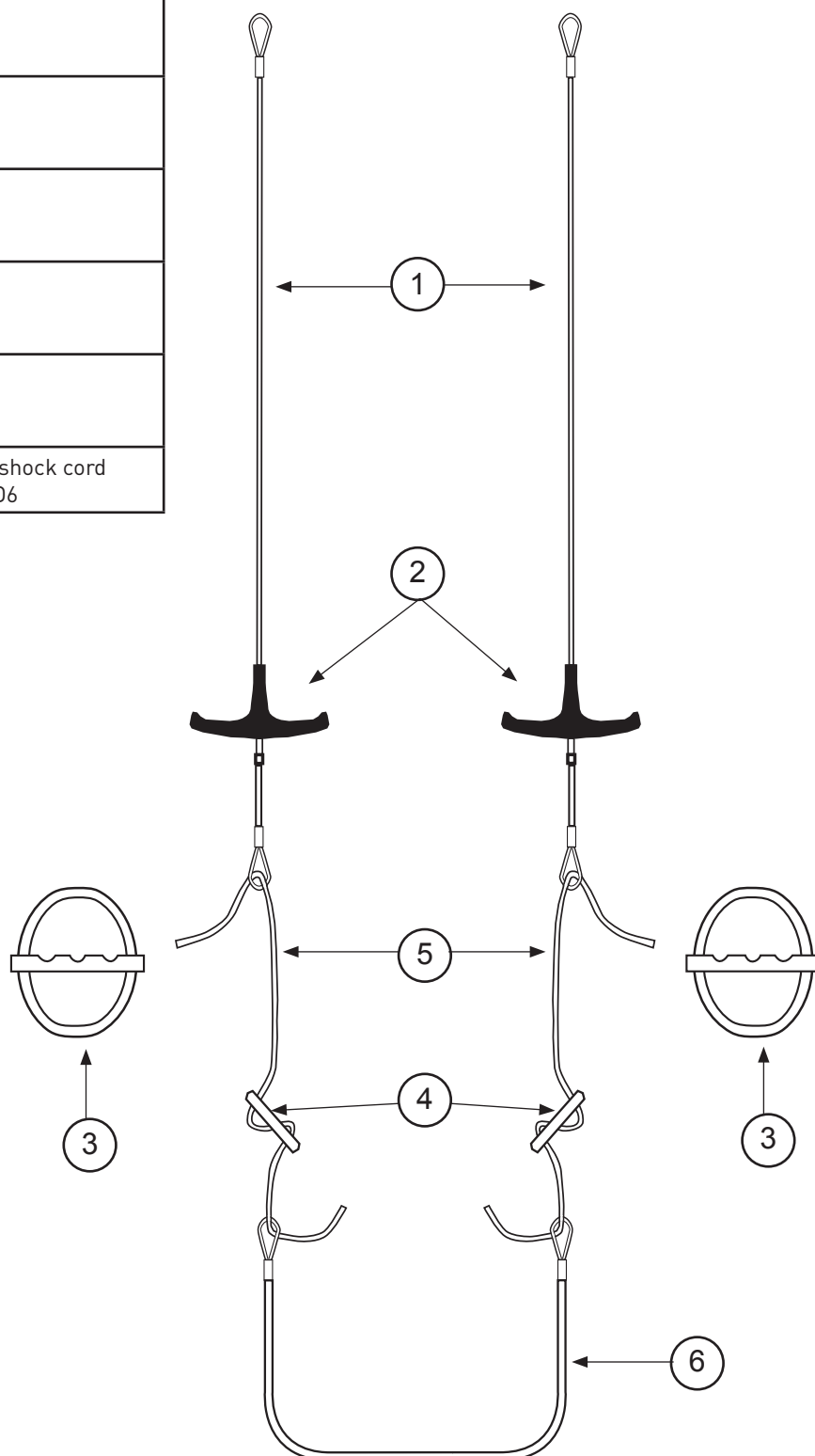

HOBIE T1

Eclaté des pièces détachées / Illustrated Part Guide / Explosionszeichnung

Gouvernail / Rudder assembly / Ruderanlage

N°	Ref	Designation/Description/Beschreibung
		Gouvernail complet droit et gauche Rudder assembly complete right & left Ruderanlage komplett rechts & links
1	12501397	Embout bras de Gouvernail T2 Rudder arm end cap T2 Ruderarm-Endstück T2
2	99502290	Lame safran Lexan easy lock 2 ins Rudder blade easy lock 2 ins Ruderblatt easy lock 2 ins
3	99220066	Vis TH 8 X 65 Screw TH 8 X 65 Schraube TH 8 x 65
	99220012	Ecrou indessérable D8 (x10) Nylstop nut D8 (x10) Selbstsichernde Mutter D8 (x10)
4	99220007	Vis TH 8 x 70 Screw TH 8 X 70 Schraube TH 8 X 70
	99220012	Ecrou indessérable D8 (x10) Nylstop nut D8 (x10) Selbstsichernde Mutter D8 (x10)
5-8	99980010	Kit pièces Easy Lock Kit Easy Lock parts Kit Easy Lock Ersatzteile
5	99980100	Casting plastique Easy Lock Plastic Casting Easy Lock Plastik-Ruderkopf Easy Lock
6	99980110	Axe plastique blocage easy lock Plastic pin Plastik Bolzen
7	99980115	Axe plastique noir Plastic pin black Plastikachse schwarz
8	99980105	Cale tampon gouvernail Easy Lock Holder for Easy Lock rudder Keil für Easy Lock Ruder
9	90880230	Clip rapide US / US fast clip
10	99300525	Sandow D5 noir / Black shock cord D5

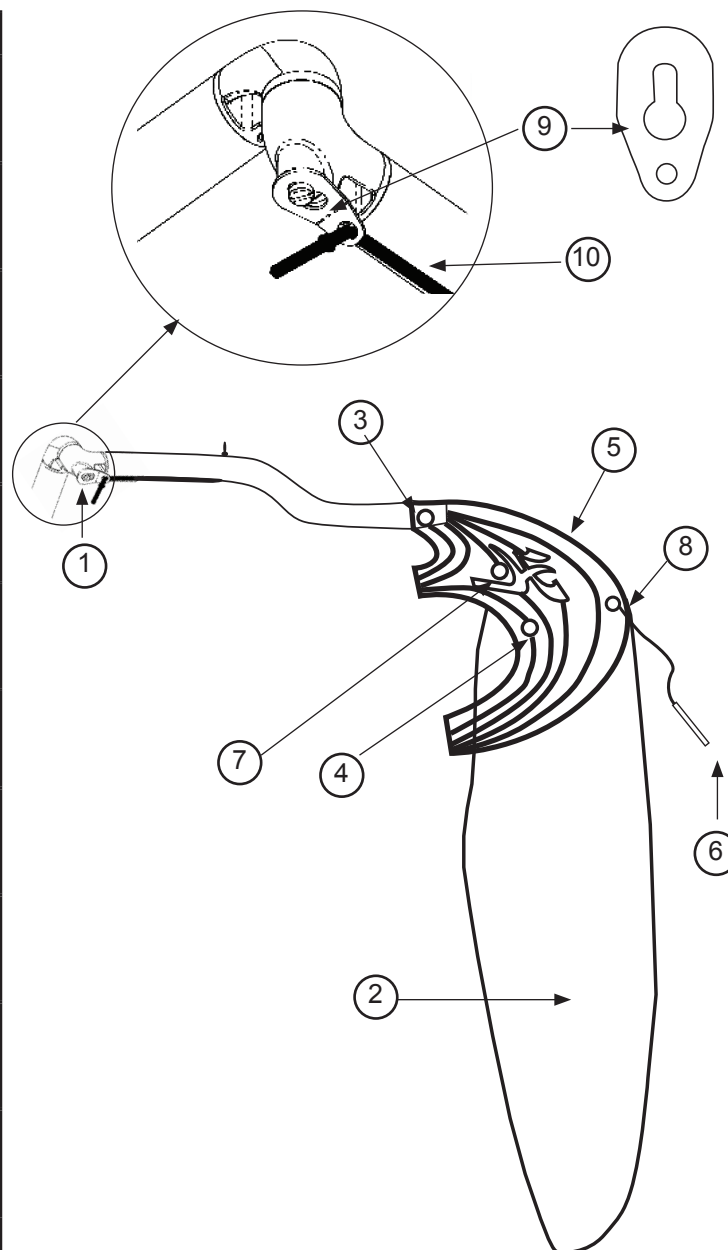

HOBIE T1
Eclaté des pièces détachées / Illustrated Part Guide / Explosionszeichnung
Barre d'accouplement & stick / Tiller crossbar & extension / Anlenkstange & Pinne

N°	Ref	Designation/Description/Beschreibung	N°	Ref	Designation/Description/Beschreibung
1-3	14662200	Barre accouplement T1 Tiller crossbar T1 Anlenkstange T1	4	14061320	Chape articulation stick (x10) Stick articulation (x10) Pinnengelenk (x10)
1	12501396	Embout barre d'accouplement Adjustable Tiller end cap Anlenkstange-Endstück	5	14061240	Axe percé (x10) Clevis pin (x10) Bolzen für Wanteisen (x10)
2	99221301	Vis violon / Violon screw / Bügel Schraube	6	99220031	Anneau brisé (x10) Split ring (x10) Ringsplint (x10)
3	99220012	Ecrou indessérable D8 (x10) Nylstop nut D8 (x10) Selbstsichernde Mutter D8 (x10)	7	14061315	Embout de stick alu (x10) Aluminium tiller extension end cap (x10) Pinnenendstück Aluminium (x10)
	99216010	Pop TB 4,8 x 11 (x 10)			
4-7	16062305	Stick aluminium Aluminium tiller extention Pinne aux Aluminium			

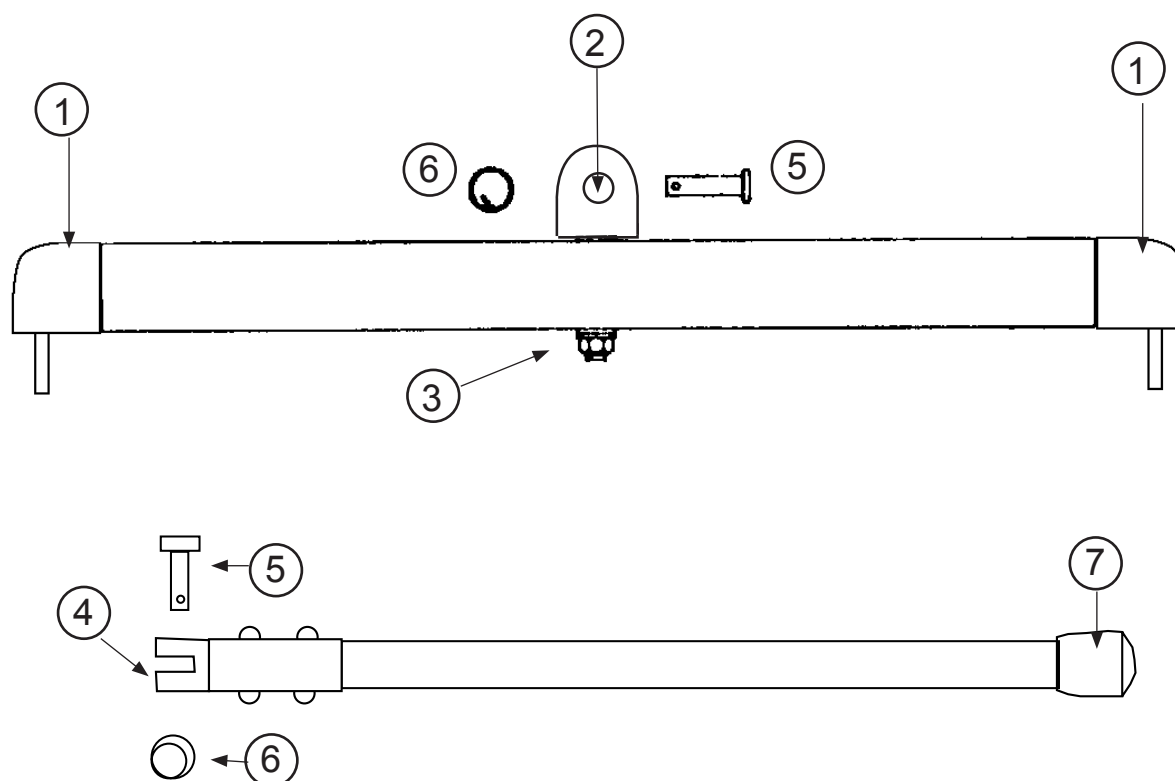

HOBIE T1

Eclaté des pièces détachées / Illustrated Part Guide / Explosionszeichnung

Grand-voile / Main sail / Großsegel

N°	Ref	Designation/Description/Beschreibung
	56990058	Grand-Voile Seabreeze Mainsail Seabreeze Großsegel Seabreeze
1-8	56016000	Jeu de lattes Batten set Lattensatz
1	56241010	N°1
2	56251010	N°2
3	56261010	N°3
4	56271010	N°4
5	56281010	N°5
6	56291010	N°6
7	56301010	N°7
	80550005	Kit butée latte GV T1 / Batten luff protector kit

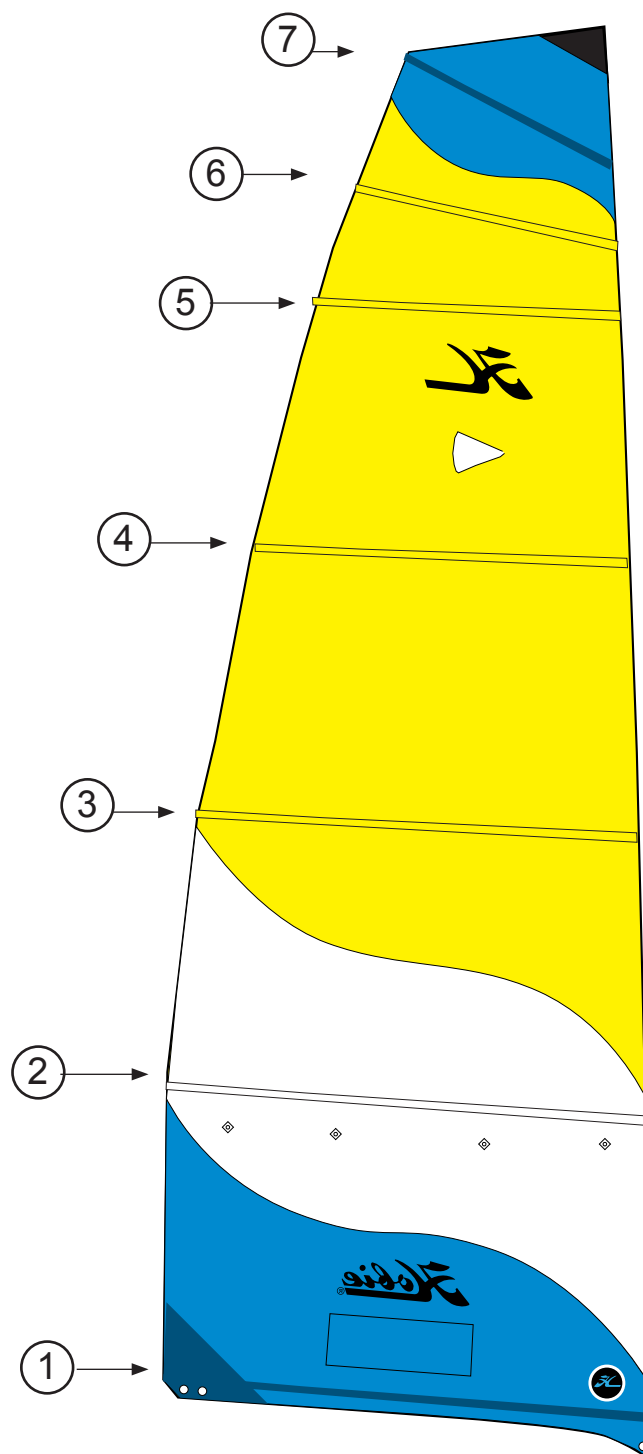

HOBIE T1

Eclaté des pièces détachées / Illustrated Part Guide / Explosionszeichnung

Palan de grand-voile / Mainsheet system / Großschot-System

N°	Ref	Designation/Description/Beschreibung
1	38900030	Crochet S / Hook S
2	56100013	Poulie ringot / Block Becket 55 mm
3	56100010	Ecoute de GV / Mainsheet
4	56100012	Poulie ringot taquet / Block Becket cleat 55 mm

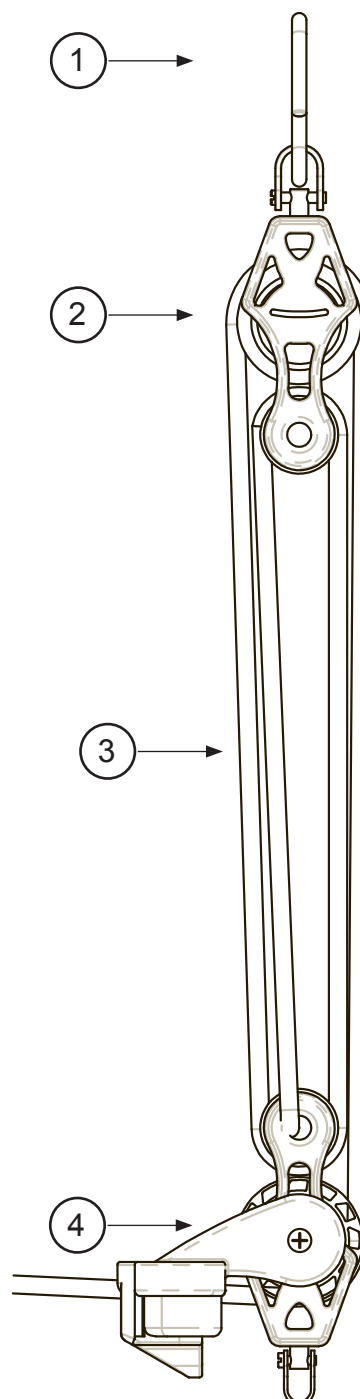

HOBIE T1

Eclaté des pièces détachées / Illustrated Part Guide / Explosionszeichnung

Foc / Jib / Fock

N°	Ref	Designation/Description/Beschreibung
	56990059	Foc T1 Seabreeze
	16080540	Drisse cordage foc Jib halyard rope Fockfalleine
		Ecoute de foc / Jibsheet / Fockshot

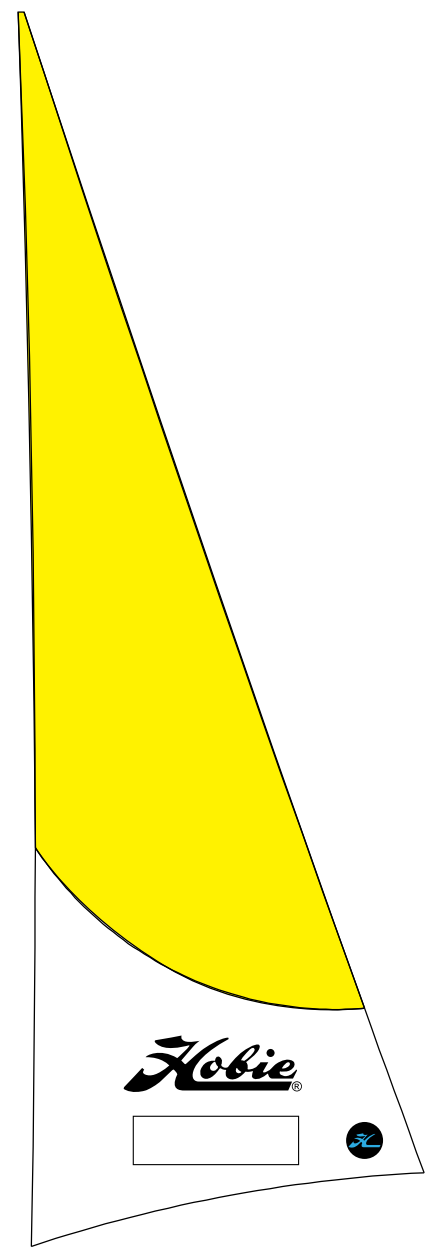
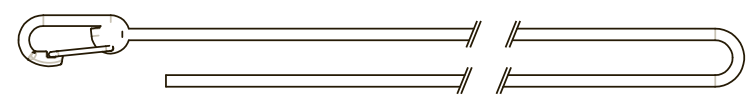

HOBIE T1

Eclaté des pièces détachées / Illustrated Part Guide / Explosionszeichnung

Kit de Spinnaker - Tangon / Spinnaker kit - Spi pole / Spi-Kit - SpiBaum (option)

N°	Ref	Designation/Description/Beschreibung
	KAVST1	Spi trompette soft T1 Trumpet soft spinnaker kit T1 Trumpet soft Spi-Kit T1
1-9	14662310	Tangon de spi trompette Spi boom trumpet Spibaum Trumpet
1	14061245	Axe barre / Connection pin / Bolzen
2	99220031	Anneau brisé (x10) Split ring (x10) Offener Ring (x10)
3	17569000	Embout bôme percé Boom end cap drilled Baumendstück gebohrt
4	18061320	Chape d'articulation tangon (x2) Spi pole connection toggle (x2) Verbindungswirbel Spibaum (x2)
	99220135	Vis / Screw / Schraube TH 8x40
	99220012	Ecrou indessérable D8 (x10) Nylstop nut D8 (x10) Selbstsichernde Mutter D5 (x10)
	99061110	Rondelle D8 (x10) Washer D8 (x10) Unterlegscheibe D8 (x10)

N°	Ref	Designation/Description/Beschreibung
5	14680595	Bride tangon trompette simple Spi boom trumpet bridle single Spibaum Trumpet Hahnepot einzig
6	99500735	Poulie avec ressort et pontet Block w/ spring and pad-eye Block mit Splint und Bügel
	99220326	Vis / Screw / Schraube SSI
6	99220015	Ecrou indessérable D5 (x10) Nylstop nut D5 (x10) Selbstsichernde Mutter D5 (x10)
	99220202	Bouchon à ailette (x5) Boom end cap (x5) Boom-Endstück (x5)
7	17070150	Poulie étarquage simple Single block Block einzig
9	99220215	Pontet coque traverse / Pad-eye / Bügel

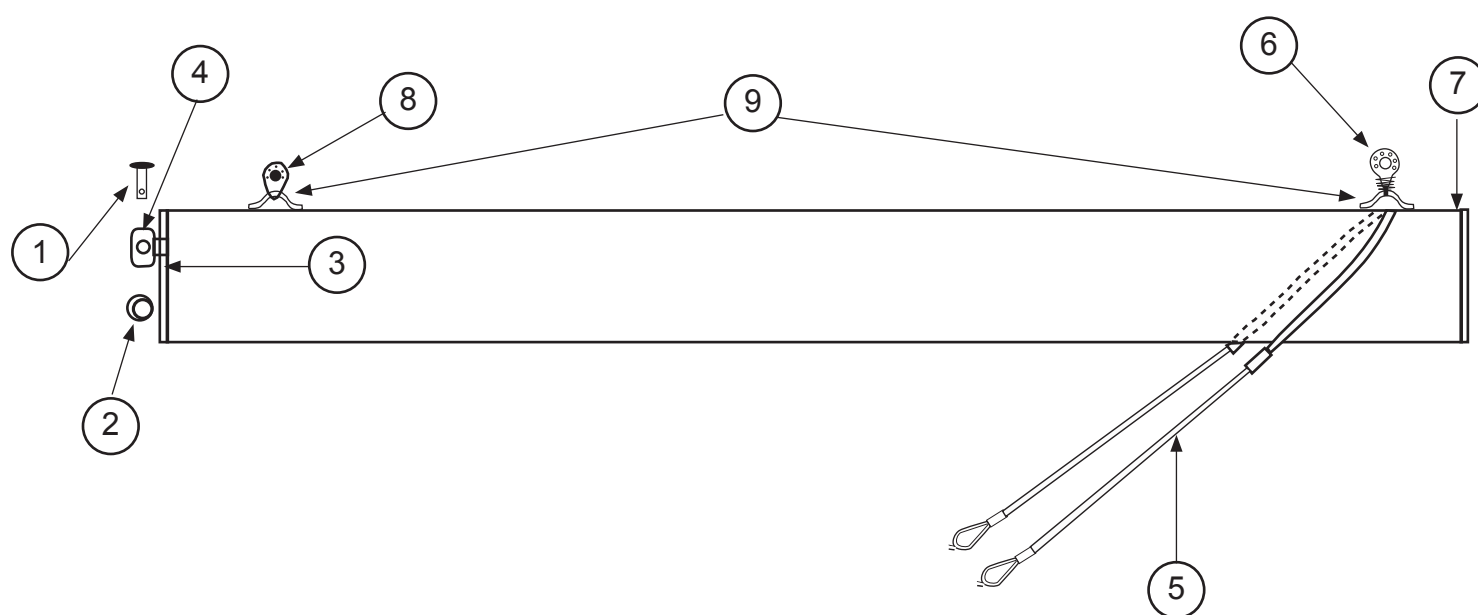

HOBIE T1
Eclaté des pièces détachées / Illustrated Part Guide / Explosionszeichnung
Kit de Spinnaker trompette / Trumpet spinnaker (option)

N°	Ref	Designation/Description/Beschreibung
	KAVST1	Spi trompette soft T1 Trumpet soft spinnaker kit T1 Trumpet soft Spi-Kit T1
1	99267528	Sac de spi / Spi bag / Spisack
2	99267760	Embout trompette de spi Spi trumpet Spinnaker-Trumpet
	99220101	Vis / Screw / Schraube T.TCLF 4,8 X 19
3-13	14670360	Accastillage spi trompette+ cordages Trumpet spi rig bag+ropes Trumpet Spi-Takelage+ Leinen
3	17070150	Poulie simple / Single Block / Block einzig
4	99300610	Cordage noir / Line black / Leine schwarz D4
5	99220036	Manille / Shackle / Schäkel D4 (x10)
6	60010950	Pontet nylon / Nylon pad-eye / Nylon Bügel
7	99500117	Poulie winch / winch Block / Knarrblock 57 mm
	99500755	Ressort plastique / Plastic spring / Plastik-Feder
	99220035	Manille / Shackle / Schäkel D6 (x10)
	99220057	Pontet / Pad-eye / Bügel D5
8	18570385	Accastillage trampoline pour spi trompette Trampoline rigging for trumpet spi Trampoline Rig für Trumpet spi
9	18070328	Poulie + sandow drisse de spi Spi halyard block + shock cord Spifallblock + Gummileine
10	99500354	Tourelle taquet carbo Swivel Cam cleat carbo Drehklemme carbo
	99500352	Support tourelle / Cam Cleat support
	99220074	Vis / Screw / Schraube TFPZ 3.9x31.7
11	99500109	Poulie tête-à-tête / Block single / Block einfacher
	13570405	Sac de cordages spi Line bag spi Leinesack spi
?	99220215	Pontet coque traverse / Pad-eye / Bügel

Illustration page suivante / illustration on the next page / Zeichnung nächste Seite

HOBIE T1

Eclaté des pièces détachées / Illustrated Part Guide / Explosionszeichnung

Kit de Spinnaker trompette / Trumpet spinnaker (option)

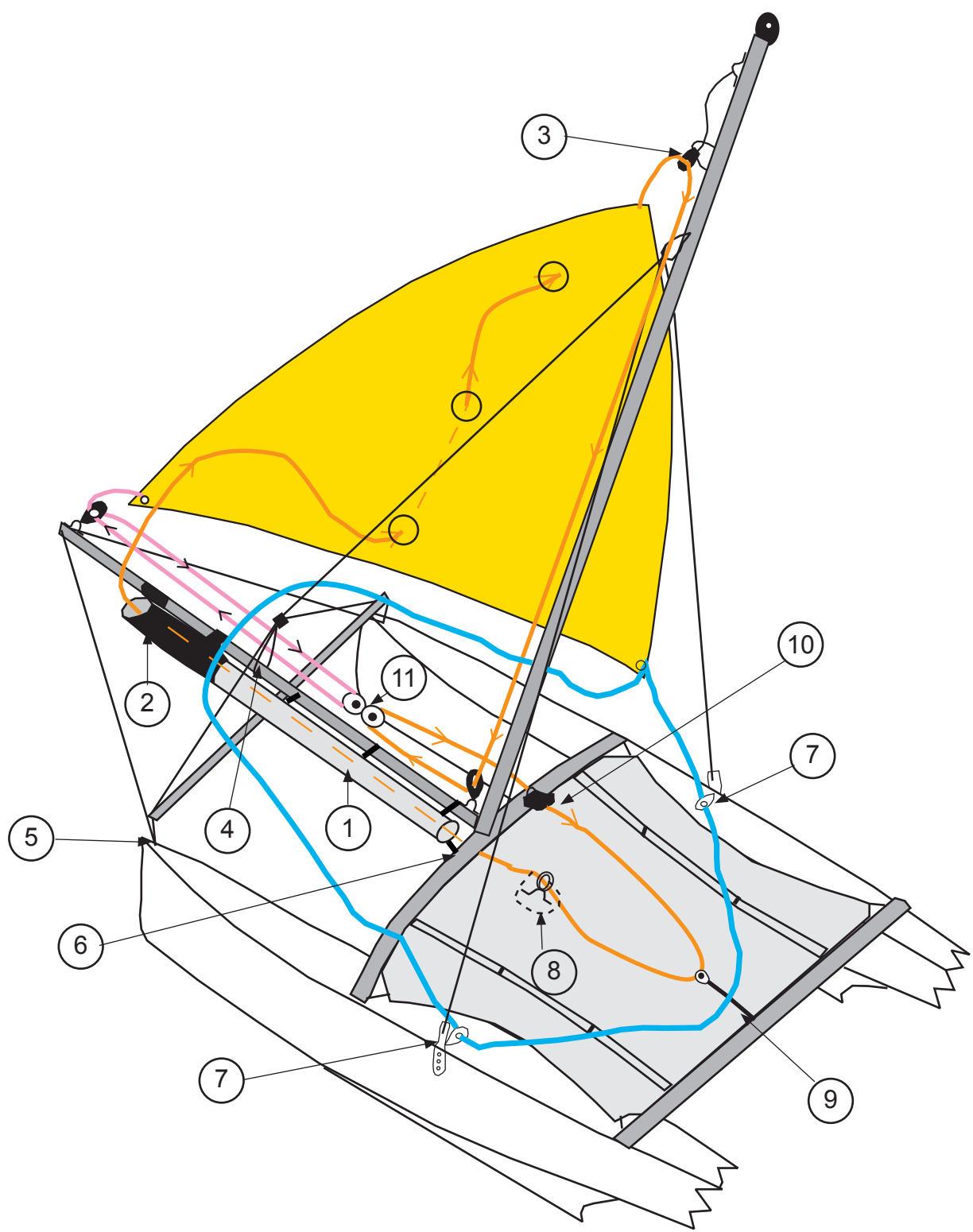



Ref : ECL_t1	Issued by :MB	Date : 12/2015	Update : 1	Page : 20/23
HOBIE T1				
Eclaté des pièces détachées / Illustrated Part Guide / Explosionszeichnung				



HOBIE CAT EUROPE

ZI Toulon Est, BP 250, 83078 Toulon cedex 9, France
Tel +33 (0)494 08 78 78 - Fax +33 (0)494 08 13 99
E-mail : info@hobie-cat.net - site web www.hobiecat.com